

B CUBE GALAXY

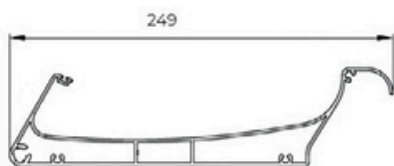

① Louver Profile



② Side Rafter & Gutter Profile

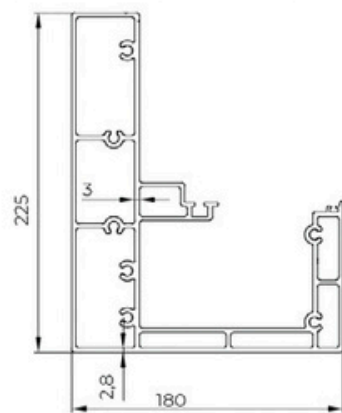

③ Front & Back Rafter & Gutter Profile

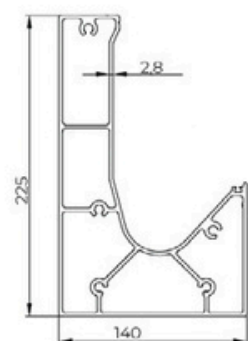

④ Profili Carrier Post Profile

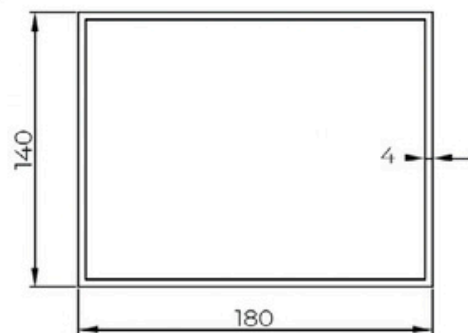

⑤ Profile for RGB

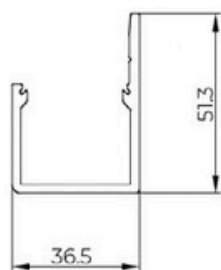

⑥ Profile for Led & RGB

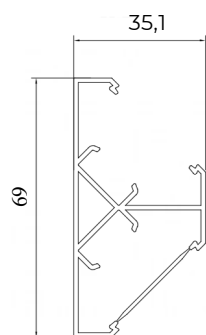

7 Rise led profile

35

35

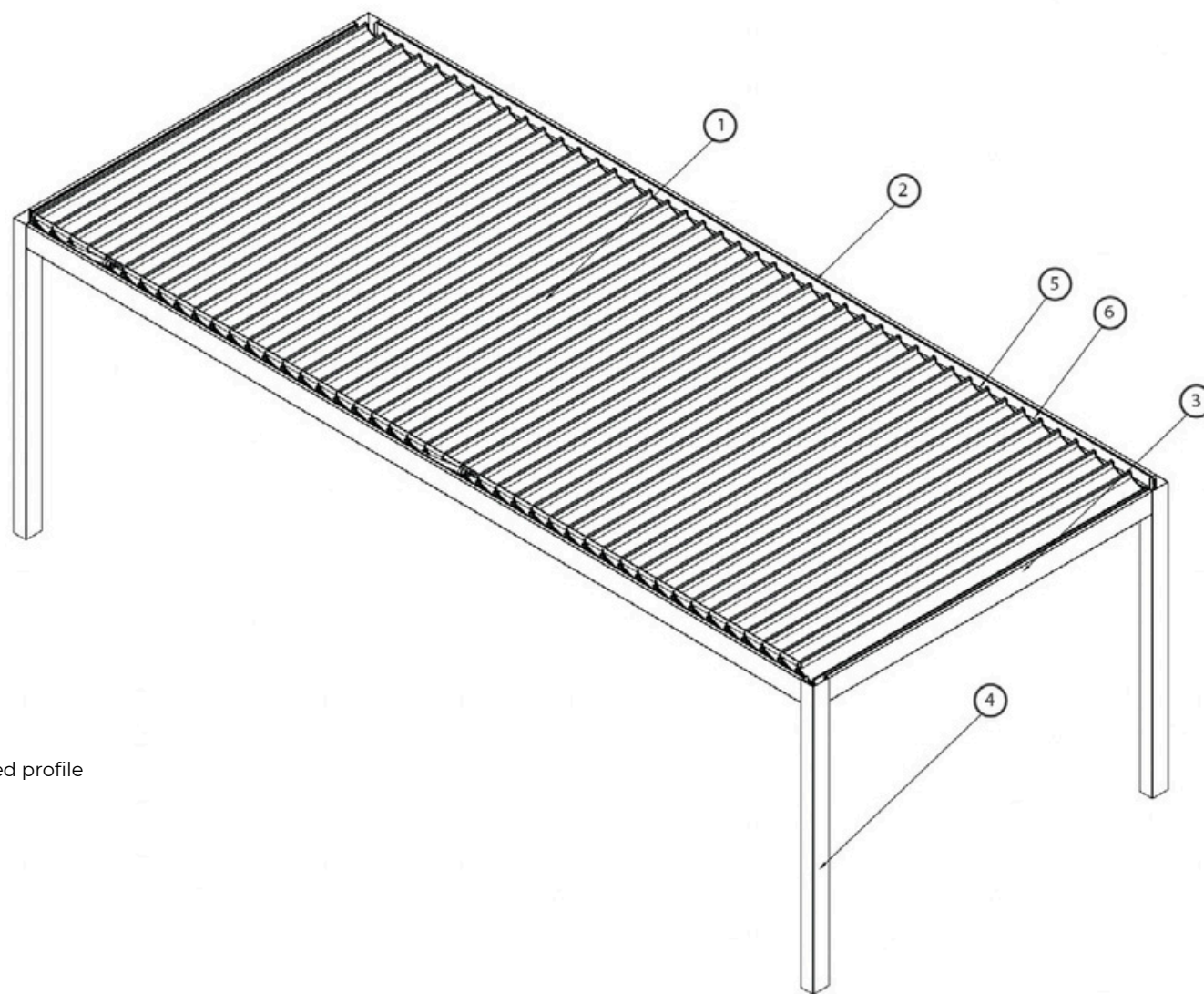

Selection of Optional Items & Accessories

B Cube Galaxy



Somfy
Wind Sensor



Somfy
Wind and Sun Sensor



Rising
Infrared Heater (2000W)



Rising
Infrared Heater (3000W)



Heater,
Dimmer Switch



LED Lighting
Integrated & Linear



Aluminium Powder
Coating



Aerosol Touch-up
Spray Paint



Bi-Metal
Holesaw



Silicone



Lighting
Dimmer Switch



Packaging with
Wooden Crate



Rising Glass
& Glazing Systems

RISE LED



GALAXY LED

