

UNIFOLIATE TECTONA

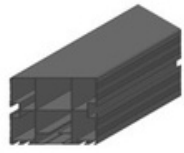

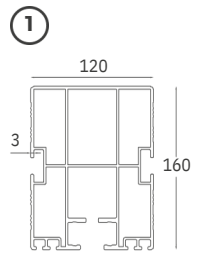

② Gutter Profile

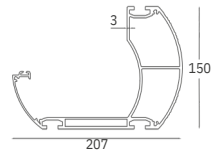

③ Carrier Post Profile

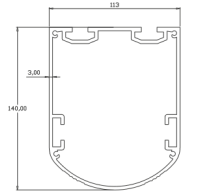

④ Fabric Profile | Master

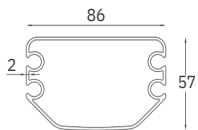

⑤ Fabric Profile | Carrier

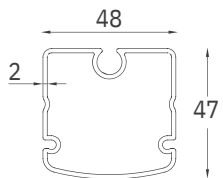

⑥ Motor Box Profile

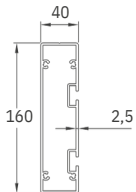

⑦ Roof Sash Profile

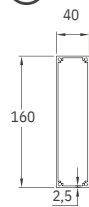

⑧ Motor Shaft Pipe Profile | Thick

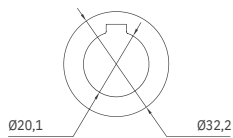

⑨ Motor Shaft Pipe Profile | Thin

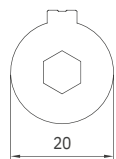

⑩ Side Beam Profile

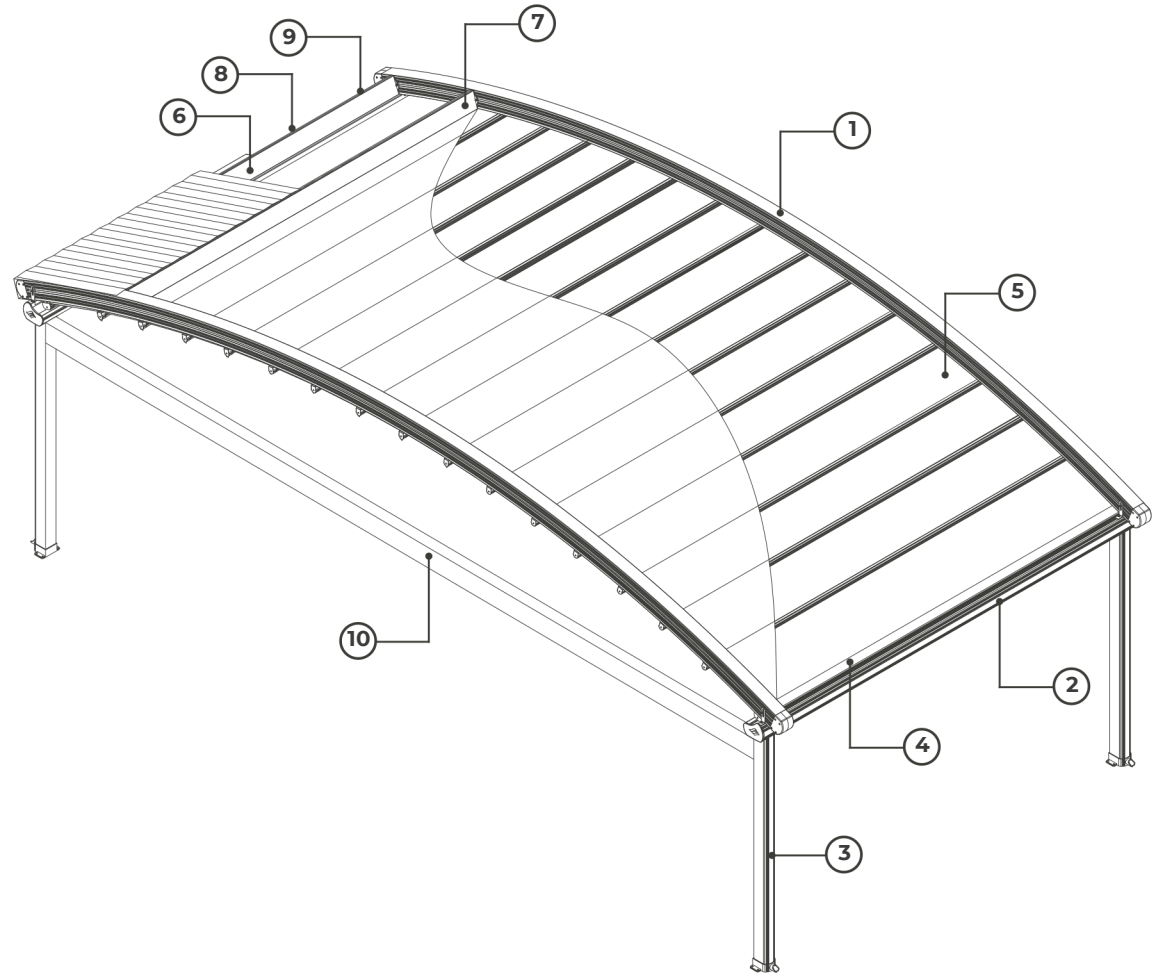
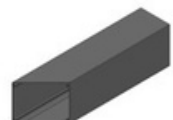
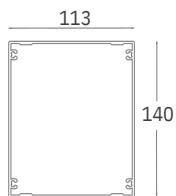

Technical Side View

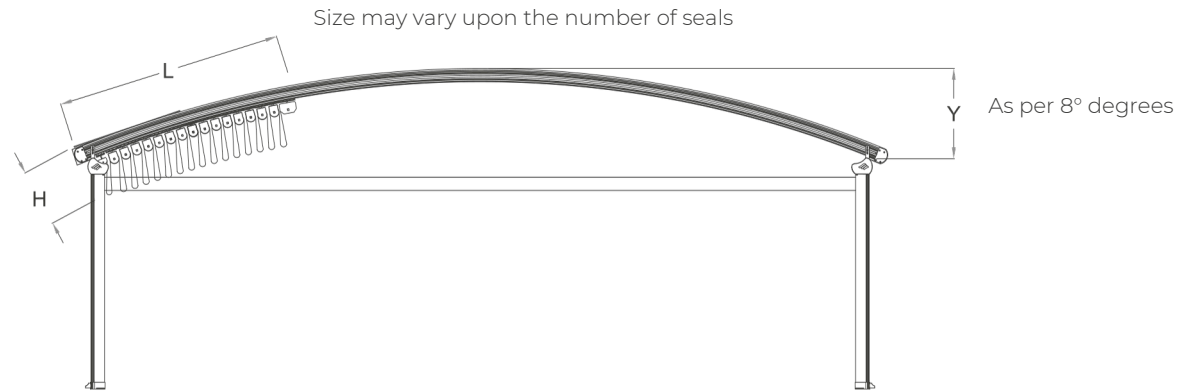

v Projection ^^^	Fabric Fall Height (H)	Hood Cover (L)	8° Degree Rule Fall Height (Y)	Fabric Profile Carrier
3000	440	660	530	8 pcs
3500	440	730	565	9 pcs
4000	440	800	600	10 pcs
4500	440	870	635	11 pcs
5000	440	940	670	12 pcs
5500	440	1010	705	13 pcs
6000	440	1080	740	14 pcs
6500	440	1150	775	15 pcs
7000	440	1220	810	16 pcs
7500	440	1290	845	17 pcs
8000	440	1360	880	18 pcs
8500	440	1430	915	19 pcs
9000	440	1500	950	20 pcs
9500	440	1570	985	21 pcs
10000	440	1640	1020	22 pcs

Single Module

Max. Width as 4500
Standard Carrier Post Profile height as 2500

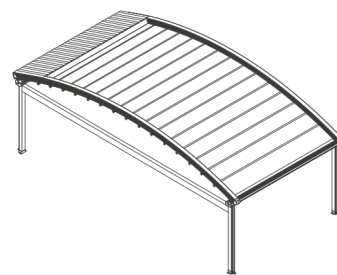

Double Module

Max. Width as 9000
Standard Carrier Post Profile height as 2500

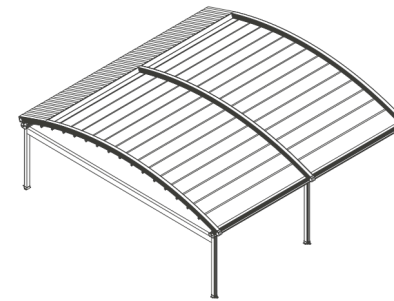

Triple Module

Max. Width as 13500
Standard Carrier Post Profile height as 2500

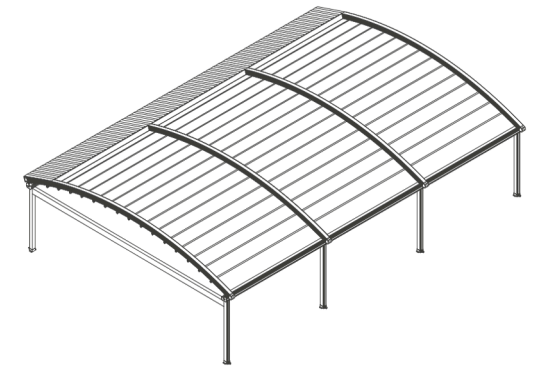

* Distances between fabric profiles had been calculated and measured as 50 cm and it may vary upon the measurement of each project therefore you are kindly requested to Contact your key account manager in order to avoid any misunderstanding other wise Rising shading systems will not be responsible for any mistakes that may occur.